



DynAmp

DIRECT CURRENT METERING SYSTEMS

Model LKP-45, LKP-60, & LKP-80

Installation, Operation and Service Manual

Manual Item No. 041592

Rev. O

This Page is Intentionally Blank

DynAmp, LLC WARRANTY

Items and components manufactured by DynAmp, LLC for permanent installation are warranted to be free from defects in material and workmanship for a period of two (2) years from the date of shipment.

Items and components manufactured by DynAmp, LLC for portable and temporary use in more than one location are warranted to be free from defects in material and workmanship for a period of eighteen (18) months from the date of shipment.

Extended warranties may be available for purchase for some products. Extended warranties are provided on a serial number by serial number basis as noted on DynAmp's original invoice and/or packing list.

Items and components not manufactured and resold by DynAmp, LLC are warranted by their manufacturer.

Warranty repair shall be, at DynAmp's option, in the form of repair or replacement of the defective items or components. Concerning warranty repairs, DynAmp, LLC will be responsible for DynAmp provided time, material and transportation costs (shipping or travel). Actual method of warranty repair / correction will be determined by DynAmp, LLC at DynAmp's sole option. Such warranty repair shall constitute a fulfillment of all DynAmp, LLC liabilities in respect to said items and components. In no event shall DynAmp, LLC be liable for consequential damages.

Information in this document is subject to change without notice.

© 1997, 1998, 1999, 2000, 2002, 2003, 2004, 2006, 2008, 2011, 2016, 2018, 2019, 2021 DynAmp, LLC. All rights reserved.

Reproduction in any manner whatsoever for purposes other than installation, operation or service by the purchaser or end user without the written permission of DynAmp, LLC is strictly forbidden.

This manual is part of the complete set of product documentation that includes installation, operation, and service instructions, drawings and test results. Users should evaluate the information in the context of the complete set of product documentation and their particular application. DynAmp, LLC assumes no liability for any incidental, indirect, or consequential damages arising from the use of this documentation.

While all information presented is believed to be reliable and in accordance with accepted engineering practices, DynAmp, LLC makes no warranties as to the completeness of the information.

All trademarks used in association with LKP are trademarks of DynAmp, LLC.

This Page is Intentionally Blank

TABLE OF CONTENTS

<u>Paragraph</u>	<u>Title</u>	<u>Page</u>
	DYNAMP, LLC WARRANTY	III
	TABLE OF CONTENTS	V
	HAZARD WARNING!	VII
	SAFETY	IX
	DYNAMP, LLC CUSTOMER SUPPORT & SERVICE ASSISTANCE	XI
	MANUAL REVISIONS	XIII
1.	HANDLING AND STORAGE	1
2.	PRODUCT DESCRIPTION	3
2.1	SYSTEM OVERVIEW.....	3
2.2	ADDITIONAL MEASURING HEAD DETAIL	3
2.3	ADDITIONAL METERING UNIT DETAIL.....	3
2.4	INTERCONNECTION CABLE DETAIL.....	3
2.5	ELECTRICAL	4
3.	SPECIFICATIONS.....	5
4.	INSTALLATION	7
4.1	HANDLING PRECAUTIONS	7
4.2	MAGNETIC CONSIDERATIONS: MEASURING HEAD	7
4.3	HEAD INSTALLATION	9
4.4	INSTALLATION CONSIDERATIONS.....	10
4.5	INSTALLATION PRECAUTIONS (LIVE BUS)	12
4.6	COMPLETING THE HEAD INSTALLATION.....	12
4.7	METERING UNIT INSTALLATION	15
4.8	METERING UNIT WIRING	16
4.9	INITIAL SYSTEM CHECKOUT	16
4.10	MAGNETIC CENTERING.....	17
4.11	REVERSING CABLE EXIT DIRECTION ON MEASURING HEAD	19
5.	THEORY OF OPERATION.....	23
5.1	GENERAL	23
5.2	MAGNETIC SENSOR (NULL DETECTOR).....	23
5.3	SYSTEM DESCRIPTIONS	23
5.4	CIRCUIT FUNCTIONS	24
5.5	METERING UNIT	25
5.6	POWER SUPPLIES.....	25
5.7	SYNC, PLL, AND RAMPS	25
5.8	ERROR AMPLIFIERS	25
5.9	COMPARATORS AND PULSE GENERATOR	25
5.10	PULSE TRANSFORMER DRIVERS	26
5.11	OUTPUT CIRCUIT	26
5.12	ACCURACY DIAGNOSTICS (OPTIONAL).....	26

6. MAINTENANCE & SPARE PARTS29
 6.1 PERIODIC MAINTENANCE29
 6.2 ANNUAL MAINTENANCE29
 6.3 RECOMMENDED CALIBRATION VERIFICATION INTERVALS30
 6.4 SPARE PARTS ORDERS - ROUTINE OR EMERGENCY31
 6.5 RECOMMENDED SPARE PARTS.....31
7. TECHNICAL BULLETINS33
8. DRAWINGS35

FIGURES, FORMS & TABLES

Figure #	Title	Page
Figure 4.1	General Guidelines for Locating Measuring Heads	8
Figure 4.2	Window Insulation Nomenclature Typical For LKP Series Heads.	9
Figure 4.3	Proper Lifting Technique	12
Figure 5.1	Magnetic Null Detector Diagram	23
Figure 5.2	Functional Diagram of Four-Channel System	24
Table 3.1	LKP Series 6 & 8 Channel Specifications	5
Table 3.2	Typical Error At Zero Bus Current	6
Table 4.1 (A)	Measuring Head Resistance Chart LKP-45	13
Table 4.1 (B)	Measuring Head Resistance Chart LKP-60	14
Table 4.2	Measuring Head Resistance Chart LKP-80	15
Table 4.3	Channel Voltage Measurements Form: LKP-45 & LKP-60	20
Table 4.4	Channel Voltage Measurements Form: LKP-80	21
Table 6.1	Spare Parts List*	32
Table 7.1	Technical Bulletin List	33
Table 8.1	Drawing List	35

Hazard Warning!



GENERAL

All installation, maintenance and service must be performed by qualified technicians who are familiar with the warnings and instructions of this manual.

The enclosure doors must remain closed at all times during operation to ensure safety of personnel. A set of keys are provided for locking the doors. Only authorized personnel or technicians should be allowed to open and service the unit.

Disconnect power to the system before servicing or replacing fuses.

Use of the equipment in a manner not specified by the manufacturer can impair the protection provided within.

DynAmp, LLC does not assume liability for the customer's failure to comply with the rules and requirements provided in this manual.



HAZARDOUS VOLTAGE

This equipment is designed to be connected to hazardous electric voltages. Ignoring the installation precautions and warnings can result in severe personal injury or equipment damage.

To avoid the risk of electrical shock or fire, the safety instructions and guidelines in this manual must be followed. The electrical specifications must not be exceeded and the unit must be installed according to directions provided.



INSTALLATION

This equipment is intended for indoor use only. It should be mounted in a well-ventilated area, away from high heat, dust, and corrosive atmosphere. The ambient temperature must not exceed the specified limits.

For mounting considerations that fall outside the recommended specifications provided in this manual, the factory should be contacted for approval.

This unit is rated for installation category III and pollution degree 2.

Symbol Identification:

General definitions of safety symbols used on equipment and manual.



Caution/Warning: Refer to accompanying documents for instructions.

This Page is Intentionally Blank

SAFETY

This equipment is designed to be connected to hazardous electric voltages. Ignoring the installation precautions and warnings can result in severe personal injury or equipment damage. Also, the equipment is heavy and requires special handling procedures to ensure the safety of both personnel and equipment itself. The following are general guidelines that should be followed when installing, operation and servicing the Metering Unit and Measuring Head.

- All installation, maintenance and service must be performed by qualified technicians who are familiar with the warnings and instructions of this manual.
- Always follow all local and plant safety procedures.
- Service must be performed by qualified technicians only. If use of an oscilloscope becomes necessary during servicing, the scope must be floating and not grounded. The Metering Unit is isolated from the mains via the power transformers. If a grounded scope is used, a hazardous condition is created since current will flow through the probe to ground.
- Units are not intrinsically safe. Do not place in explosive atmospheres
- Do not place in the rain, or under water, or submerge any part of the Measuring Head or Metering Unit. The Measuring Heads are splash proof but are not waterproof.
- The surface on which the Measuring Head is mounted must be sound and capable of supporting the head. Fasteners used must be capable of supporting the weight of the head.
- **Make sure that the cables are disconnected from the Measuring Head during installation.**
- The Measuring Heads are supplied with connector covers, which must be used whenever the head cables are disconnected from the Measuring Head. The covers are necessary to prevent dust and water from entering the Measuring Heads. The covers also prevent fingers from contacting the connector pins during installation, which can carry hazardous voltages if the head is installed on a live bus.
- If the installation is to be made on a "live" bus, the Measuring Head cables must be disconnected from the head. A condition hazardous to the Measuring Head and any person handling un-insulated cable-lead terminals will result if metal parts of the head contact the bus, or sudden changes in the bus current occur. Personal protective gear should be worn when reconnecting cable back to Measuring Head. **Please refer to "Installation Considerations" section 4.4 for head storage on a live bus.**
- Measuring Head should be electrically isolated from the bus bars. A ¼" (6mm) minimum distance between the bus and window insulation should be maintained. This will insure electrical isolation of the head structure from the bus. The Measuring Head itself is grounded via the cables to the Metering Unit. Refer to the "Installation Considerations" section of the manual for more details.
- An external circuit breaker or fuse with proper rating is required for branch circuit protection when wiring the main circuit to this Metering Unit. Each Metering Unit must have its own breaker. Use a wire and breaker or fuse (time-delay) sized

adequately for the maximum burden of 20 VA/kA of measured current. The wire should have an insulation rating of 600Vac and 80°C minimum temperature rating.

- Replace fuses with correct type, size and value. All channel fuses are Time lag MDA (or MDL) style 3AB (or 3AG) ¼" by 1 ¼" (6.3 mm x 32mm), 250 Volt. Refer to the servicing instructions or spare parts list for more information on replacement fuses. Do not bypass the fuses or modify the electronics. Disconnect power to the System before replacing fuses. Failure to follow these instructions will result in intermittent operation and premature failure and will void the warranty.
- Metering Unit enclosure doors and module covers must be present and remain closed at all times during operation to insure safety of personnel. A set of keys is provided for locking enclosure doors. Only authorized personnel or technicians should be permitted to open and service the unit.
- Bus current must be zero when taking resistance measurements.
- Use of the equipment in a manner not specified by the manufacturer can impair the protection provided within.

DynAmp, LLC does not assume liability for the customer's failure to comply with the rules and requirements provided in this manual.

DynAmp, LLC Customer Support & Service Assistance

For further assistance, contact DynAmp Customer Support at:

Americas:

Telephone: +1 614.871.6900

Fax: +1 614.871.6910

8:00 AM to 5:00 PM USA Eastern Time

From first Sunday in November to second Sunday in March – 13:00 GMT to 22:00 GMT

From second Sunday in March to first Sunday in November – 12:00 GMT to 21:00 GMT

After Hours Critical Service Emergency:

Telephone: +1 614.871.6906

5:00 PM to 8:00 AM USA Eastern Time

From first Sunday in November to second Sunday in March – 22:00 GMT to 13:00 GMT

From second Sunday in March to first Sunday in November – 21:00 GMT to 12:00 GMT

Central e-mail:

help@dynamp.com

DynAmp web:

www.dynamp.com

This Page is Intentionally Blank

MANUAL REVISIONS

<u>Page</u>	<u>Change</u>	<u>Reason For Revision</u>	<u>Date</u>
All	Rev New		6/97
10	Rev A	Installation Notes	12/97
12	Rev A	Installation Considerations	
14, 15	Rev A	Measuring Head Resistance Chart	
33	Rev A	Spare Parts List	
35	Rev B	Drawing list	12/97
All	Rev C	Safety, Installation, & Drawing list	5/98
14,15	Rev C1	Typing Error - Table 4-1 & 4-2	9/99
All	Rev D	Warranty, Safety, Installation Considerations, Maintenance & Spare Parts, Added Related Technical Bulletins section	04/00
29, 36, 39	Rev E	Updated Accuracy Diagnostics, Spare Parts section, Technical Bulletin list	01/02
iii, 7	Rev F	Updated Warranty and Installation paragraph	09/03
all	Rev G	Update to DynAmp, LLC, update Table 2 – Measuring Head resistance chart LKP-80	11/04
v, 1, 34, 36	Rev H	Update fuse precautions per ECR 1304	07/06
41	I	ECO 3166 update accuracy diagnostics drawings/list	09/08
All	J	PAR 10245 – Handling & Storage, ECR 1440- Calibration Intervals / New Manual Format	01/11
1,2,13,18	K	ECO 3307 – Section 1 Safety, Installation Precautions, Metering Unit Wiring	10/16
2,22,23,33, 39	L	ECR 1955 / ECO 3330 – Update fuse value for LKP-45 - Safety, Change Note in Table 5.3 & 5.4, Spare parts list 7.1,and Drawing list size changes 9.1	11/16
6, 35, iii, xi	M	ECO 3350 – Remove obsolete MVI & SVI options, Add head assembly torque, Add drawing revisions in Table 8.1, Update title blocks in drawings, and General verbiage updates for Warranty Page and Customer Support & Service	09/18
35	N	ECO 3350 – Update drawing 02C108033 to 02A108033 Rev C	08/19
35	O	ECO 3360 – Update drawing 83A108255 to Rev C	02/21

This Page is Intentionally Blank

1. HANDLING AND STORAGE

DynAmp products are engineered and manufactured for use in industrial environments. However, they contain sensitive electronic and mechanical components which may be damaged and fail if not handled and stored properly. All products must be handled and stored with the same care as any precision measurement instrument. Severe bumps or jolts may damage internal parts and cause malfunction or premature failure. DynAmp products are designed and assembled with conformal coating, shock mounting, and environmental seals, when appropriate or when specified. However, this protection requires that the product must be properly installed and operational before the protection is fully functional. Therefore, adequate protection from humidity, shock, and temperature must be provided during handling and storage prior to installation.

The handling and storage of equipment must be sufficient to meet the storage temperature and humidity specifications of the product and to prevent any condensation or contact with water or any other liquid. The storage location and container or crate must provide adequate protection from precipitation (rain, snow, ice) and direct water contact. Adequate shelter must be provided to prevent the accumulation of precipitation (rain, snow, ice) and water which can lead to the deterioration or failure of shipping containers or crates and cause water ingress. Storage in coastal or industrial areas subject to salt-laden or corrosive air or areas of wind-driven sand or other abrasive dust must be adequate to prevent the deterioration or failure of shipping containers or crates and cause ingress. Frequent inspection of storage areas and storage containers or crates is required to ensure proper storage conditions are being maintained.

If the shipping container or crate is opened and/or the equipment is removed for inspection prior to installation, the equipment must be repackaged in the original undamaged container or crate in the same manner as it was shipped to prevent environmental damage or placed in a storage location that meets the required environmental and storage conditions.

General product storage temperature and humidity requirements:

Storage Temperature: -40 to 70°C
 -40 to 158°F

Storage Humidity: Maximum 85%, non-condensing

DynAmp, LLC does not assume liability for the customer's failure to comply with handling and storage requirements.

For further assistance, contact DynAmp customer support.

This Page is Intentionally Blank

2. PRODUCT DESCRIPTION

2.1 SYSTEM OVERVIEW

The DynAmp, LLC LKP Series 6 & 8 channel are systems for accurately measuring direct current in a bus. The Models in this series are: LKP-45 and LKP-60 (6 channel), and LKP-80 (8 channel). Each model consists of a two-piece Measuring Head, a Metering Unit, and two multi-conductor cables. For the sake of simplicity throughout this manual, the LKP 6 and 8 channel Metering Units might be referred to as the LKP system, or LKP metering system.

2.2 ADDITIONAL MEASURING HEAD DETAIL

A magnetic core encircles the bus passing through the center of the Measuring Head. Magnetic null detectors are mounted in air gaps in the core. Each null detector is flanked by coils located on the magnetic core.

The Measuring Heads are constructed of cast aluminum with a tough epoxy finish, insulation from the bus being provided by a 3/8 in. (9.5mm) layer of high-grade epoxy. The head halves are easily joined around the bus by use of 8 bolts.

The LKP-60 and LKP-80 Measuring Heads are provided with mounting feet as standard equipment. The mounting feet facilitate the mounting of the heads vertically on the floor or on a platform. The LKP-45 can be provided with mounting feet or with a bus bar mounting kit (both are optional).

2.3 ADDITIONAL METERING UNIT DETAIL

The Metering Unit is housed in a standard NEMA 12 enclosure (IP54). In addition to the electronic circuitry (housed within two modular units), the Metering Unit contains terminals for all external connections. The Metering Unit requires 120/240 Vac (other voltages available), 50 or 60 Hz power. Burden on the supply circuit will not exceed 2400 VA. A thermo-magnetic circuit breaker is mounted on the inside of the enclosure and serves as the power on-off control.

2.4 INTERCONNECTION CABLE DETAIL

A standard 33-foot (10 meter) interconnecting cable is supplied with each system (longer cable lengths are available - consult the factory for details). Each of the individual conductors is tagged with a numbered label corresponding to a terminal block connection, providing an easy hookup to the Metering Unit. Keyed connectors are provided on the Measuring Head side of the cables to ensure correct hookup.

2.5 ELECTRICAL

Six outputs are provided by the system:

1. A standard voltage output exists at terminals TS2-6 and TS2-7 inside the Metering Unit. The output voltage is 1mV/kA for model LKP-80, and 10mV/kA for models LKP-45 and LKP-60.
2. An additional voltage at TS2-8 and TS2-9, when an optional shunt is installed.
3. A current output of 1 A_{dc} per 5 kA of bus current, at TS2-4 and TS2-5. The current output is available by removing a jumper connected across the terminals (do not remove the jumper while the system is energized). Maximum allowable voltage drop across the terminals is 15 V_{dc} at the normal maximum current output of the bus.
4. A normally-open (N.O.) relay contact for the Metering Unit over-temperature alarm, rated at 120 Vac, 6 A, at TS2-12 and TS2-13.
5. A normally closed relay contact for accuracy diagnostics output at TS2-12 through TS2-14. This feature is only available when the accuracy diagnostics option is ordered.
6. Optional isolated shunt output. Scaling is per customer order: 0-10V, 4-20mA available.

3. SPECIFICATIONS

TABLE 3.1
LKP SERIES 6 & 8 CHANNEL SPECIFICATIONS

MODEL	MAX. FULL-SCALE RANGE*	MEASURING HEAD WEIGHT	METERING UNIT WEIGHT
LKP-45	45 kA	172 lb. (78 kg)	300 lb. (136 kg)
LKP-60	60 kA	297 lb. (135 kg)	300 lb. (136 kg)
LKP-80	80 kA	396 lb. (180 kg)	330 lb. (150 kg)

Ambient Temperature Range of Measuring Head	-20°C to 55°C
Ambient Temperature Range of Metering Unit Location	-20°C to 55°C
Humidity (head and Metering Unit)	85% maximum
AC Line Voltage at 50 or 60 Hz $\pm 5\text{Hz}^{**}$	100,120,200,220,240 Vac +10%, -15%
Burden on ac Line: ***	20 VA/kA
Maximum Allowable Burden of Output Circuit	15 volts
Linearity Error \diamond	$\pm 0.03\%$ of full scale from 5% to 100% of bus current.
Repeatability Error Limits \diamond	$\pm 0.02\%$ of full scale plus zero error. $\diamond\diamond$
Temperature Sensitivity	$\pm 0.002\%/^{\circ}\text{C}$
Line Voltage Sensitivity	$\pm 0.001\%/V$ @ 120V ac $\pm 0.0005\%/V$ @ 240V ac
Measuring Head To Bus Isolation $\diamond\diamond\diamond$	12kVac for 1 minute with 25mm air gap. See notes below.
Installation Category	III
Pollution Degree	2

* Contingent upon DynAmp, LLC. computer analysis of bus system.

** The LKP systems are factory-set for the correct voltage and frequency (50 or 60 Hz) per customer order. To operate an LKP system at a different line frequency than was ordered, move jumper JP1 (located on the control board inside each module) to the desired frequency. Refer to the wiring diagrams for changing the input voltage.

*** Size any external isolation transformers for 30VA/kA to avoid overheating the transformers due to the presence of SCR generated harmonics on the input ac line.

\diamond When tested at 120 Vac, less than 1 V burden, 24°C ambient.

$\diamond\diamond$ Typical zero primary current errors (bus equiv.) for each model are shown in table 3.2.

$\diamond\diamond\diamond$ With bus passing through window insulation at 90° to the head.

**TABLE 3.1
LKP SERIES 6 & 8 CHANNEL SPECIFICATIONS, CONTINUED**

OUTPUTS	
Current output:	1 A/5 kA, $\pm 0.1\%$ full scale
Voltage output, LKP-45, LKP-60	10mV per kA of bus current, $\pm 0.1\%$ full scale
Voltage output, LKP-80	1mV per kA of bus current, $\pm 0.1\%$ full scale

PHYSICAL	
Overall Dimensions, in. (mm):	
LKP Metering Unit (all)	48(1219) H x 36(914) W x 16(406) D
LKP-45 Measuring Head	31 (772) H x 33(839) W x 6.7(170) D
LKP-60 Measuring Head	36 (905) H x 40(1008) W x 11.8(300) D
LKP-80 Measuring Head	45 (1134) H x 48(1220) W x 11.8(300) D
Aperture Dimensions in. (mm):	
LKP-45 Measuring Head	20.9 (530) H x 20.9(530) W
LKP-60 Measuring Head	23.4 (595) H x 23.4(595) W
LKP-80 Measuring Head	30.5 (775) H x 30.5(775) W
Torque – Head assembly bolts (head top half to bottom assembly)	M8 – tighten until snug. Never exceed 14 N.m (125 lb. in.)

NOTE
<p>The Measuring Head window insulation rating is directly proportional to the clearance of the head to the bus. For instance, a bus in direct contact with the window insulation of the head will have an insulation rating of 6kV. A clearance of 1" increases the window insulation rating to 12 kV. Thus, the greater the distance through the air between the bus and the head, the greater the insulation rating will be.</p>

TABLE 3.2 TYPICAL ERROR AT ZERO BUS CURRENT

Models	Max. Core Set
LKP-45	± 6.75 amperes
LKP-60	± 9 amperes
LKP-80	± 12 amperes

- See section 4.2 concerning magnetic effects of external buses.

4. INSTALLATION

4.1 HANDLING PRECAUTIONS

Even though the LKP Series systems are large and rugged, they should be handled with the same care as any precision measuring instrument. Larger Measuring Heads are quite heavy, and adequate handling equipment must be available. Severe jolts or bumps to the head or Metering Unit may cause movement of internal parts, and possibly a malfunction. It is also advisable to avoid supporting the head-halves by the windows insulation. The window insulation is tough, but brittle. **Personnel involved in the installation should be experienced with equipment of similar size and weight. They should also be familiar with the technical terms, warnings, and instructions in this manual, and all plant safety rules, and be able to follow these.**

The complete system should be inspected for shipping damage at the earliest opportunity. Visible damage must be reported to the carrier immediately. Concealed damage (not evident until the system is operated) must be reported to DynAmp, LLC immediately.

4.2 MAGNETIC CONSIDERATIONS: MEASURING HEAD

The LKP metering systems are designed and built for accuracy, stability, and reliability. However, these factors may be adversely affected by the arbitrary location of the Measuring Head without regard for magnetic fields. Secondary magnetic fields emanating from angled sections of the bus being monitored or from other nearby buses may cause overheating. Currents from other buses produce magnetic fields, which can sometimes cause zero offsets and errors at low current levels. To guard against these problems, a computer analysis of the bus system should be performed. If a bus analysis is not feasible, the guidelines presented this section can be used as a starting point.

FREE BUS ANALYSIS

The general guidelines below should be applied only when a detailed analysis of your bus system is not available. DynAmp, LLC will perform one detailed computer analysis of the proposed location of the Measuring Heads within your bus system at no charge. Generally, this is done before or at the time the unit is ordered. In this way you are assured that your LKP system will function properly.

Whenever possible, the head should be installed on the longest straight run of the bus that is available in an area free of other bus structures. General guidelines requiring consideration when installing a Measuring Head are shown in figure 4.1 (guidelines illustrated are to be considered as the minimum required distances). If the proposed head location can be physically described by more than one of the diagrams (figure 4.1), a bus analysis should be performed. For the guidelines of figure 4.1 to apply, the **bus** height-to-width ratio should equal the **head aperture** height-to-width ratio, within $\pm 10\%$. This ratio does not affect the accuracy of the measurement, but it does affect the loading of different sections of the Measuring Head.

a = maximum aperture dimension

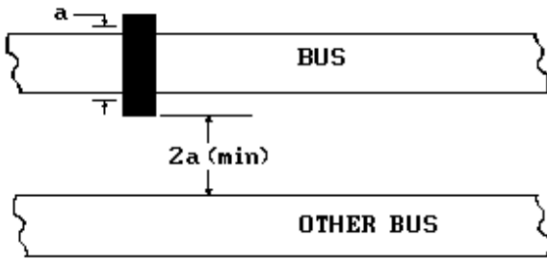

The head should be a minimum distance of $2a$ from another bus carrying equal or less current. If the other bus carries higher current, the distance should be greater, e.g., $3a$.

The head should be located a minimum distance of $2a$ from a 90° bend in the bus.

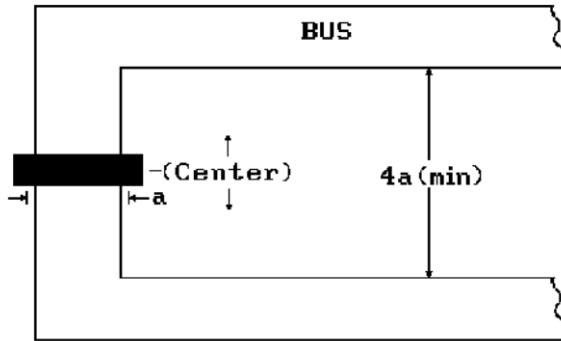
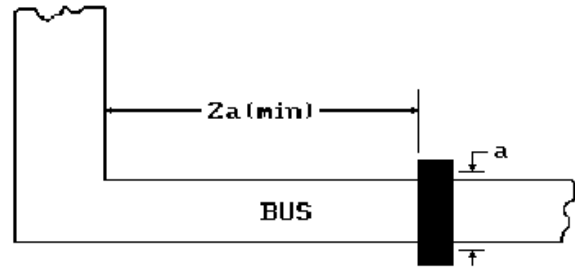

If the head is to be installed on a U-section of the bus, the distance between the parallel bus sections must be a minimum of $4a$, and the head should be centered between them.

If the head is to be installed on a T-section of the bus, it should be located a minimum distance of $4a$ from the joining point.

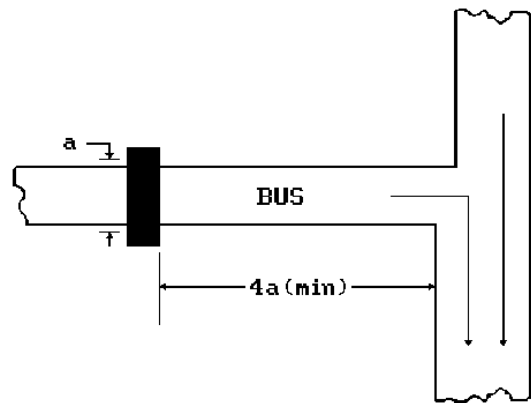

Figure 4.1 General Guidelines for Locating Measuring Heads

4.3 MEASURING HEAD INSTALLATION

There are two connector fittings on the Measuring Head (one on each half). These fittings are not to be used for lifting. Proper lifting is accomplished by using eyebolts in the holes provided in the channel flanges or corners. Choker slings may be used around the head as long as strong lateral pressure on the edge of the window insulation is avoided (see note below).

Before actually installing the Measuring Head on the bus, the head may be checked for damage to the head and performing a head resistance check per Table 4.1 first, if desired. This is accomplished by connecting the cables with the head removed from the bus. After the procedure is complete, the head should be mounted according to the instructions in this section.

Check the mating faces of the Measuring Head. Make absolutely certain that the serial numbers of both halves of the head match; otherwise you may cause misalignment and unit failure. Use only a small brush or cloth to remove any dirt particles from the head part-line insulation, multi-conductor connector and latch areas.

NOTE

When installing the Measuring Head, protect the window insulation from impact, and do not let the weight of the Measuring Head rest upon the window insulation as it can be easily damaged. Also, the interconnecting cable is of top quality, but it is not armored. Protect it from abrasion and sharp edges.

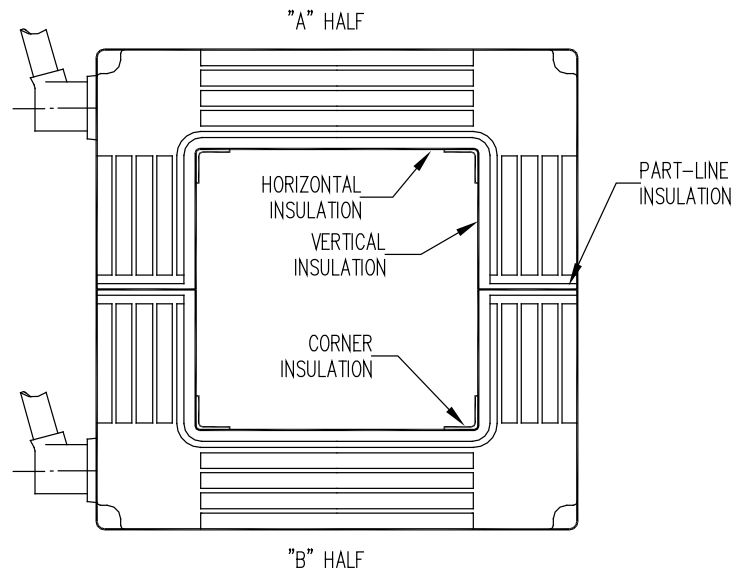

**Figure 4.2 Window Insulation Nomenclature
Typical For LKP Series Heads.**

NOTE

The head must be installed with current arrows in the same direction as conventional current flow in the bus. No damage will occur if the head is reversed, but the system will not produce an output.

4.4 INSTALLATION CONSIDERATIONS

In general, the Measuring Head can be installed vertically, horizontally, or in any intermediate orientation. The LKP-45 can be mounted by using the Busbar mounting kit (purchased separately). Alternatively, optional mounting feet (standard on LKP-60 and LKP-80) can be purchased that can simplify mounting the head to the floor or a platform. The prime considerations in all cases are as follows:

Read and follow the following considerations before mounting the head.

- A.) Choose a mounting location where the ambient air temperature does not exceed 55°C. The standard head is designed for indoor use only and should be kept away from high heat and corrosive atmospheres. Protect the Measuring Head from direct sunlight which causes the head temperature to rise, thus limiting the upper operating range in some applications. If the Measuring Head is to be installed in a harsh environment, please discuss protective measures with the factory.
- B.) The Measuring Head must be protected from water. The LKP and LKB sensor head designs rated 15 kA and higher are tested to meet IP 64 when manufactured, indicating protection from splashing water from any direction. However, this rating is not a blanket approval for simply installing it outdoors without additional water protection. The Measuring Heads are splash proof but are not waterproof. Classification IP 64 acknowledges that some water may penetrate the seal. Water that invades the sensor is likely to cause long-term destruction. Consequently, it is necessary to provide some rain and snow protective covering if the equipment is to be mounted outdoors or in the vicinity of a sprinkler system.
- C.) To minimize distortion of the magnetic field as seen by the head, temporary and final support members should be nonmagnetic (for example, aluminum beams, struts or stranded cables, or wood, fiberglass, or Phenolic where appropriate). It is recommended to keep large structural magnetic materials at least 2 meters distant from the Measuring Head. For additional details, refer to Technical bulletin No. 987 titled "Ferromagnetic Materials Near LKP or LKB Current Sensors."
- D.) The Measuring Head is designed to be supported from the bottom. The top half should be attached to an anti-tipping brace. **Never suspend the head by the top half alone.** If the Measuring Heads are to be mounted in a position other than vertical, each half of the Measuring Head should be independently supported. Additional drilling of the head is NOT authorized, as damage may result.
- E.) When mounted, the two head halves of the head should be in the same plane so no distortion of the part line will occur. No tension, twist, or excessive pressure should be applied to the part line.
- F.) The Measuring Head should be electrically insulated from the bus. A 6mm (1/4") minimum distance between the bus and window insulation should be maintained in dry, clean air. More separation should be maintained if the bus voltage is greater than 1000 Volts or if the air quality is bad. This will insure electrical isolation of the Measuring Head structure from the bus. **The aluminum head structure is grounded via the cables to the Metering Unit. Do not short between the head structure and the bus to prevent serious damage or injury.** For that reason, always disconnect the cables from the head prior to installation or maintenance. Touching both an energized bus bar and grounded Measuring Head may result in electrical shock.

- Most models interconnection cables have a GRN/YEL wire that is used for Measuring Head grounding. To electrically float the head above ground potential, the GRN/YEL wire from each cable must be disconnected at the Metering Unit. Note that for safety reasons, the Metering Unit cabinet should be grounded at all times.
- G.) Do not loosen any of the bolts that hold the Measuring Head casting sections together. Doing so, will compromise the seal between parts and allow water or contaminants to enter the head.
 - H.) The Measuring Head must be installed with current arrows in the same direction as conventional current flow in the bus. An arrow indicates the direction that conventional bus current must flow through the aperture (+ to -). No damage will occur if the Measuring Head is reversed, but an LKP system will not produce an output in this condition.
 - I.) **CAUTION:** The part-line insulation pieces (located on the mating surfaces of the head) contain sensitive electronic devices, are brittle, and can be easily damaged if one is not careful during installation.
 - J.) Make sure that the serial number on the top half of the Measuring Head matches the serial number of the lower half, and that the halves go together squarely and evenly without forcing, twisting, or cocking.
 - K.) Try to mount the Measuring Head in an area free of other bus bars. This is not an essential requirement if a satisfactory magnetic centering can be achieved.
 - L.) Final head position will be determined by the magnetic centering process, so the Measuring Head support members should be temporary at first. If a bus analysis has not been performed, the Measuring Head should be geometrically centered on the bus during the initial installation. If a bus analysis was performed, follow the recommendations for initial positioning, and also perform the centering process.
 - M.) After final magnetic centering, the Measuring Head must have adequate support.

Sudden changes or shutdown of bus current can induce high voltages in open coil circuits inside the Measuring Head. This is a risk of shock if someone is in contact with the connector pins during the event. There is a slight possibility of connector or coil damage if the Measuring Head is left un-operation (stored) for prolonged periods on a live bus with frequent fluctuations. The following precautionary measures must be taken to prevent damage and risk of shock.

Best option is to leave the cables connected between Metering Unit and Measuring Head. Even if the Metering Unit is not powered, it will shunt induced currents in the coil and prevent high voltage from developing. If that is not feasible then use one of the following options:

- i. The Measuring Head cable leads from the channel feedback coils must be shorted together and isolated from all other cable leads and ground wire to prevent induced high voltages on the coil leads. Refer to the Head Resistance Chart and /or schematics for coil circuit wire numbers.

Warning : Keep all exposed head cable leads from touching the bus, ground, or any support structures.

- ii. Consult with DynAmp about using a shorting plug at each connector.

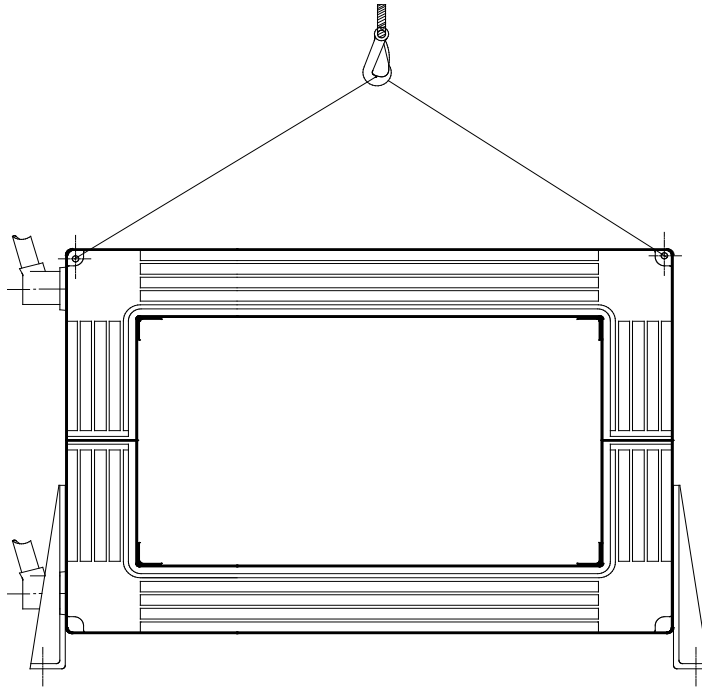

Figure 4.3 Proper Lifting Technique

4.5 INSTALLATION PRECAUTIONS (LIVE BUS)

If the unit is to be installed on a live bus, the following precautionary measures must be taken before installing the Measuring Head:

- A.) Make sure that the cables are disconnected from the head during installation.
- B.) Always follow all local and plant safety procedures.

WARNING

If the installation is to be made on a "live" bus, the Measuring Head cables must be disconnected from the head. A condition hazardous to the Measuring Head and any person handling un-insulated cable-lead terminals will result if metal parts of the head contact the bus.

4.6 COMPLETING THE MEASURING HEAD INSTALLATION

With the Measuring Head temporarily installed and bus current off (or the head removed from the bus for verification prior to installation), complete the following steps:

- A.) Connect the interconnecting cable directly to the Measuring Head. Note that the connectors are keyed and can only be connected one way.
- B.) Before connecting the other end of the interconnecting cable to the Metering Unit, perform the ohmmeter tests in Table 4.1. The tests are made from the open end of the cable, looking back towards the Measuring Head. Record these values for future reference.

NOTE

You cannot get good ohmmeter readings if the Measuring Head is on a live bus. The coils pick up induced voltages from any rectifier ripple. The Hall plate resistance changes in a high magnetic field.

Notes on Measuring Head Resistance Charts - Table 4.1 & 4.2 below:

1. BUS CURRENT MUST BE ZERO OR MEASURING HEAD REMOVED FROM BUS when taking resistance measurements.
2. Use a high impedance DMM set on the lowest range appropriate for the measurement. Measurements are made between cable leads listed, at Metering Unit end of Cable. The resistance values shown in the table are for readings obtained with cable disconnected from the Metering Unit. Split channels 1 and 4 (5 in LKP-80) will read half the resistance values when measured with all the cables connected to the Metering Unit.
3. These resistance readings are the room temperature values of the copper channel coils. Measured values can be 50% higher if head is hot and/or cable length is longer than 30 feet.

**TABLE 4.1 (A)
MEASURING HEAD RESISTANCE CHART
LKP-45**

Measure Between Leads:	Desired Value (Ohms)	Circuit
CABLE TO "A" HALF OF MEASURING HEAD		
24 & 29	22-24	Coil Circuit - Channel #1A
25 & 30	10.5-12	Coil Circuit - Channel #2
26 & 32	10.5-12	Coil Circuit - Channel #3
27 & 31	22-24	Coil Circuit - Channel #4A
21 & 19	1000-1300	Hall Current - Channel # 1, 2, 3
11 & 12	240-550	Hall Signal - Channel #1
13 & 14	240-550	Hall Signal - Channel #2
15 & 16	240-550	Hall Signal - Channel #3
CABLE TO "B" HALF OF MEASURING HEAD		
53 & 56	22-24	Coil Circuit - Channel #4B
52 & 58	10.5-12	Coil Circuit - Channel #5
49 & 55	10.5-12	Coil Circuit - Channel #6
48 & 54	22-24	Coil Circuit - Channel #1B
46 & 44	1000-1300	Hall Current - Channel # 4, 5, 6
40 & 41	240-550	Hall Signal - Channel #4
36 & 37	240-550	Hall Signal - Channel #5
38 & 39	240-550	Hall Signal - Channel #6

TABLE 4.1 (B)
MEASURING HEAD RESISTANCE CHART
LKP-60

Measure Between Leads:	Desired Value (Ohms)	Circuit
CABLE TO "A" HALF OF MEASURING HEAD		
24 & 29	22-24	Coil Circuit - Channel #1A
25 & 30	10.5-12	Coil Circuit - Channel #2
26 & 31	10.5-12	Coil Circuit - Channel #3
27 & 32	22-24	Coil Circuit - Channel #4A
21 & 19	1000-1300	Hall Current - Channel # 1, 2, 3
11 & 12	240-550	Hall Signal - Channel #1
13 & 14	240-550	Hall Signal - Channel #2
15 & 16	240-550	Hall Signal - Channel #3
CABLE TO "B" HALF OF MEASURING HEAD		
53 & 56	22-24	Coil Circuit - Channel #4B
52 & 58	10.5-12	Coil Circuit - Channel #5
49 & 55	10.5-12	Coil Circuit - Channel #6
48 & 54	22-24	Coil Circuit - Channel #1B
46 & 44	1000-1300	Hall Current - Channel # 4, 5, 6
40 & 41	240-550	Hall Signal - Channel #4
36 & 37	240-550	Hall Signal - Channel #5
38 & 39	240-550	Hall Signal - Channel #6

TABLE 4.2
MEASURING HEAD RESISTANCE CHART
LKP-80

Measure Between Leads:	Desired Value (Ohms)	Circuit
CABLE TO "A" HALF OF MEASURING HEAD		
24 & 29	21-22	Coil Circuit - Channel #1A
25 & 30	10.5-12	Coil Circuit - Channel #2
26 & 31	10.5-12	Coil Circuit - Channel #3
27 & 32	10.5-12	Coil Circuit - Channel #4
28 & 33	21-22	Coil Circuit - Channel #5A
21 & 19	750-1000	Hall Current - Channel # 1, 2, 3, 4
11 & 12	240-550	Hall Signal - Channel #1
13 & 14	240-550	Hall Signal - Channel #2
15 & 16	240-550	Hall Signal - Channel #3
17 & 18	240-550	Hall Signal - Channel #4
CABLE TO "B" HALF OF MEASURING HEAD		
52 & 58	21-22	Coil Circuit - Channel #5B
49 & 55	10.5-12	Coil Circuit - Channel #6
50 & 56	10.5-12	Coil Circuit - Channel #7
51 & 57	10.5-12	Coil Circuit - Channel #8
48 & 54	21-22	Coil Circuit - Channel #1B
46 & 44	750-1000	Hall Current - Channel # 5, 6, 7, 8
36 & 37	240-550	Hall Signal - Channel #5
38 & 39	240-550	Hall Signal - Channel #6
40 & 41	240-550	Hall Signal - Channel #7
42 & 43	240-550	Hall Signal - Channel #8

4.7 METERING UNIT INSTALLATION

The location of the Metering Unit should be determined by the following factors:

- A.) An indoor location where the ambient air temperature is within -20°C to +55°C at all times should be used.
- B.) The location should be within reach of the head cable length to be routed.
- C.) The location should be approximately 8 feet (2.5 meters) or more from high current bus bars. (Some installations have been made much closer to high current buses without difficulty, but the distance given is on the safe side.)
- D.) Mount the Metering Unit on a wall, column, instrument panel, or other convenient location (refer to outline and mounting diagram in the back of the manual).

4.8 METERING UNIT WIRING

Terminate all conductors from the Measuring Head as shown in the interconnection diagrams in the back of this manual. As an aid to wiring, each conductor is identified by a numbered sleeve (or imprinted numeral), which corresponds to the correct terminal destination. You should always use the wire numbers when making connections as wire colors may vary, or appear different under certain lighting conditions. If the wire ends get damaged and require re-stripping, use high quality wire strippers and set the strip length to 0.39" (10mm).

Install and connect the output-monitoring devices to the appropriate terminals at the Metering Unit. If current output is used, remove the factory-installed jumper and connect the desired current output circuitry, using an adequate wire size. Make sure that the burden imposed by the wire is not excessive.

NOTE
If bus current is on, <u>bus ripple or sudden changes in bus current level</u> will induce significant voltages in the feedback coils. Therefore, the cables must be disconnected from the Measuring Head while wiring them to the Metering Unit.

Complete the wiring job by connecting the external power lines to terminals TS1-3 (COMMON), TS1-2 (HOT), and TS1-1 (GROUND) in the Metering Unit.

Customer is responsible for supplying an external circuit breaker or fuse with proper rating as required by local codes for branch circuit protection when wiring the mains circuit to this Metering Unit. Each Metering Unit must have its own breaker. Use a wire and breaker or fuse (time delay) sized adequately for the maximum burden of 20 VA/kA of measured current. The wire should have an insulation rating of 600Vac and 80°C minimum temperature rating.

If an external transformer is being used to supply power to the Metering Unit, consider sizing the transformer to 30VA/kA. Over-sizing the transformer will keep its temperature rise to a minimum due to the harmonic rich content of the AC current drawn by the Metering Unit.

4.9 INITIAL SYSTEM CHECKOUT

Recheck all wiring connections against the drawings to ensure proper installation. When they are satisfactory, turn on the system by first closing the external breaker or disconnect (if used), and then the Metering Unit circuit breaker. Confirm that the amber POWER lamp is ON.

With the bus energized, the Metering Unit's output in use should accurately measure the bus current. However, it is now necessary to take a complete set of channel voltage readings. These readings serve two purposes - One, to verify that all channels are operating properly and two, to aid in magnetic centering of the head. With the bus current operating at its highest operating level, take two sets of readings, the first set taken immediately (to verify no condition exists that may cause damage to the LKP Metering Unit), and the second set after a 24-hour period of time (to thermally stabilize the head). Proceed as follows:

- A.) The dc voltage range may be as high as 75 Vdc (point "D" below). Make certain the voltmeter being used is set to measure average dc volts in this range.
- B.) The measured bus and all other high current buses in the vicinity (or in the facility, within 10-20 meters away) should be operating at or near their highest levels. Note: All magnetic field sources will affect the channel voltage readings.
- C.) Make a photocopy of a table "Form for Recording Channel Voltage Measurements", depending on the model. The initial readings are made as instructed on the form, and are recorded in the individual blocks, which graphically show channel locations on the head.
- D.) Excluding the effects of external magnetic sources and assuming a full rated bus current, each channel is expected (by calculation) to measure approximately 18 V to 30 Vdc. In practice, channel readings should be more on the order of 10 V to 30 Vdc, but that may not be achievable. A channel failure will usually be indicated by either a full-off (near zero), half-on (35-38 V) or full- on (70-75 V) condition.

CAUTION

Avoid operating the unit for an extended time with any channel output over 40 V. This will permanently damage the system. For voltages over 40 V, consult the factory.
--

- E.) If any of the channel readings do indicate trouble, refer to Theory of Operations and Maintenance & Spare Parts sections and resolve the problem; then proceed with "Magnetic Centering".

Note 1. Low Readings: A very low amplifier output voltage may be normal for certain channels; however, ripple can be as high as 3 V on a non-operating (full-off) channel. Thus, a very low reading (i.e., 2 V to 5 V, should be suspected as a possible problem; subsequent head movement or other magnetic change may show that the channel is good. A blown channel fuse can cause a low reading.

Note 2. High Readings: The maximum allowable channel output of 40 V relates to the maximum heat dissipation that the channel can safely handle. A reading of 30 V to 40 V makes a change in head position highly desirable. A reading exceeding 40 V makes a head position change necessary. A reading of 70-75 V indicates a full-on channel condition or a blown channel fuse, and requires immediate action to resolve the problem. A reading of 35-38 V when immediately adjacent channels are significantly different may indicate that one of the two SCRs in the channel has failed.

4.10 MAGNETIC CENTERING

The distribution of load, or heat, among all channels will be optimized by magnetic centering of the head relative to both the bus and the total magnetic environment of the Measuring Head. In general, this simply means moving the head so that channels with high voltage readings will be farther from the bus, and channels with low readings will be nearer the bus. Whether or not the head should actually be moved depends on three factors:

- A.) The possible impracticality or difficulty of moving the head because of support-system requirements, clearances available, etc.
- B.) The necessity of moving the head because of voltage readings that are too high or too low for certain channels.

C.) The desirability of moving the head to obtain a better balance of channel voltages.

Study the initial voltage readings. First, if none of the readings are below 3 V or above 30 V, the head position may be left as is. If some of the voltages are in the 31-40 V range, a change should be considered. In some cases, a channel fuse might blow if the channel voltage is above 35 volts. In those cases, the head will have to be moved, or, if the head can't be moved, then a higher rated fuse can be installed. Using higher rated channel fuses shall be evaluated and approved by the factory only on a case-by-case basis. If any readings are over 40 V, the head must be moved.

As the voltage readings are compared from channel-to-channel around the head, a pattern may be observed which indicates that a section of adjacent channels has higher-than-average readings, whereas the section 180° across the bus has lower readings. Looking for patterns of this type will help in deciding how the head should be moved to obtain a better balance of channel voltages.

As a simplified example of optimizing the head position, assume these readings are obtained for two pairs of directly opposite channels:

<p>Chan 1 = 25 V and Chan 5 = 12 V Chan 3 = 36 V and Chan 7 = 12 V</p>
--

Note that it is not sufficient to consider just a few channels; all channel readings must be considered for repositioning. However, for this simplified example the head would be raised (relative to the bus) to balance the channels 3 and 7 voltages, and moved horizontally (bringing channel 5 nearer the bus) to balance the channels 1 and 5 voltages. Note that (1) it would not be necessary to change the horizontal positioning since the channel 1 voltage is not excessive and (2) an absolute balance between opposing channels is unnecessary. Lowering the higher readings (31 V or higher) is more important than achieving perfect balance.

CAUTION

If the head position must be changed it is important that it be kept in a vertical plane if possible. The head can be mounted in a tilted plane without loss of accuracy. However such mounting can impose stresses at the center joining points especially if one half is supported solely from the other half.

If it is necessary to tilt the head out of the vertical plane by more than 20° to achieve lower channel voltages, first make sure each half is independently supported at four points, and then carefully loosen the joining bolts. Independently move each half into the new position, visually align. Firm up the support system and re-bolt. A gap of at least ¼in. (7 mm) must be maintained between any part of the head and bus to prevent possible buildup of a conductive dust path between them.

Using the initially recorded channel data, move the head position as necessary or desirable, observing the above precautions. Make spot readings of the channels in question to confirm results. When the spot readings are satisfactory, record their values and measure and record the values of all other channels on the diagram in Table 4.3 or Table 4.4 "Form for Recording Channel Voltage Measurements". (Additional copies may be made to use for spot readings or trial runs.) Check the diagram to see if the position is now satisfactory. Once balance is apparently achieved, it is advisable to let the system operate 24 hours to thermally stabilize the head. Then make any necessary adjustments and record the final position values on one of the book copies of the table 4.3 or 4.4 and label accordingly. (This data will be valuable for future troubleshooting or maintenance.)

When the desired final position of the head has been obtained, return to “Completing the Measuring Head Installation” section 4.6, step b, to complete the system installation.

4.11 REVERSING CABLE EXIT DIRECTION ON MEASURING HEAD

The cables are normally connected to the Measuring Head such that both cables point upwards. This is to facilitate routing the cables through conduit. However, there are instances when it is desirable to have the top cable on head half “A” (cable A) point downward to allow for the installation of a shroud or weather protecting enclosure directly above the head. The following procedure is for changing the top cable exit direction:

1. Disconnect ac power to the Metering Unit.
2. Disconnect the top cable from the Measuring Head.
3. Note the original position of the guide pins and guide sockets (located at the corners of the connector). Remove the guide pins and sockets.
4. Gently pull out the connector pin housing being careful not pull excessively on the delicate cable wires. Rotate the pin housing $\frac{1}{2}$ a turn (180°) and reinsert into the connector.
5. Reinstall the guide pins and sockets in a pattern directly opposite the original position (i.e. replace the sockets with the pins and the pins with the sockets).
6. Reconnect the cables to the head and reapply ac power to the Metering Unit.

Warning:
With the system on a live bus, the ac power is off, and the cable disconnected from the head, a shock hazard exists on the measuring head connector terminals.

**TABLE 4.3
CHANNEL VOLTAGE MEASUREMENTS FORM: LKP-45 & LKP-60**

If the channel voltages are measured and recorded at least two hours after the LKP system is energized has been properly "centered" electrically, the information may prove valuable in the event of any future malfunction.

It is a good idea to take an additional set of readings at the hottest time of the year, especially if the equipment is exposed to outdoor temperatures; space is provided for the recording of three sets of readings.

NOTE: Although the channel voltages may vary widely with temperature extremes, best accuracy is achieved when individual channel voltage falls within the limits 70-130% of the average of all channel voltages. Maximum limits are +35Vdc and +40Vdc for LKP45 and LKP-60 respectively. Refer to "Magnetic Centering" section.

Channel voltages are measured between terminals at the Metering Unit terminal block with the LKP in service on an energized bus.

INSTRUCTIONS

1. Record the channel measurements for every channel (make additional copies of this form as needed).
2. Supply the information called for below.

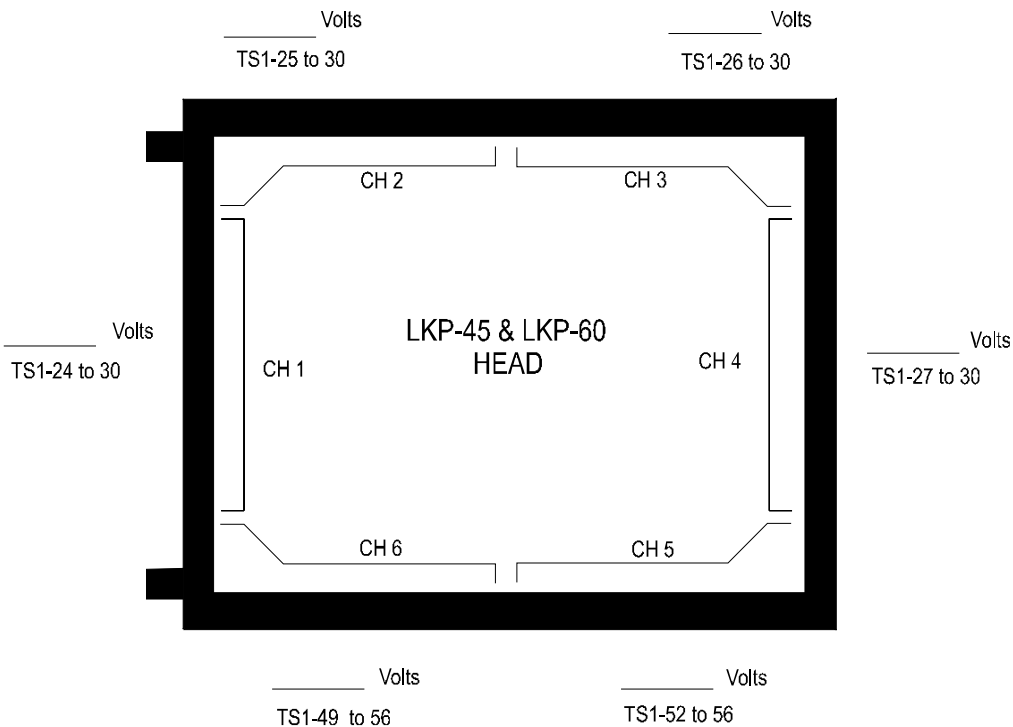

CHANNEL VOLTAGES

Ambient Temperature: _____

Date: _____

<input type="checkbox"/> LOOP BURDEN (TS2-4 & -5)			
<input type="checkbox"/> LINE VOLTAGE: (TS1-2 & -3)			
<input type="checkbox"/> BUS CURRENT (kA):			

Serial Number of LKP-45 or LKP-60: _____

**TABLE 4.4
CHANNEL VOLTAGE MEASUREMENTS FORM: LKP-80**

If the channel voltages are measured and recorded at least two hours after the LKP system is energized has been properly "centered" electrically, the information may prove valuable in the event of any future malfunction.

It is a good idea to take an additional set of readings at the hottest time of the year, especially if the equipment is exposed to outdoor temperatures; space is provided for the recording of three sets of readings.

NOTE: Although the channel voltages may vary widely with temperature extremes, the accuracy will remain unaffected so long as each channel voltage falls within the limits 70-130% of the average of all channel voltages. Maximum limits are +40 Vdc*. Refer to "Magnetic Centering" section.

Channel voltages are measured between terminals at the Metering Unit terminal block with the LKP in service on an energized bus.

INSTRUCTIONS

1. Record the channel measurements for every channel (make additional copies of this form as needed).
2. Supply the information called for below.

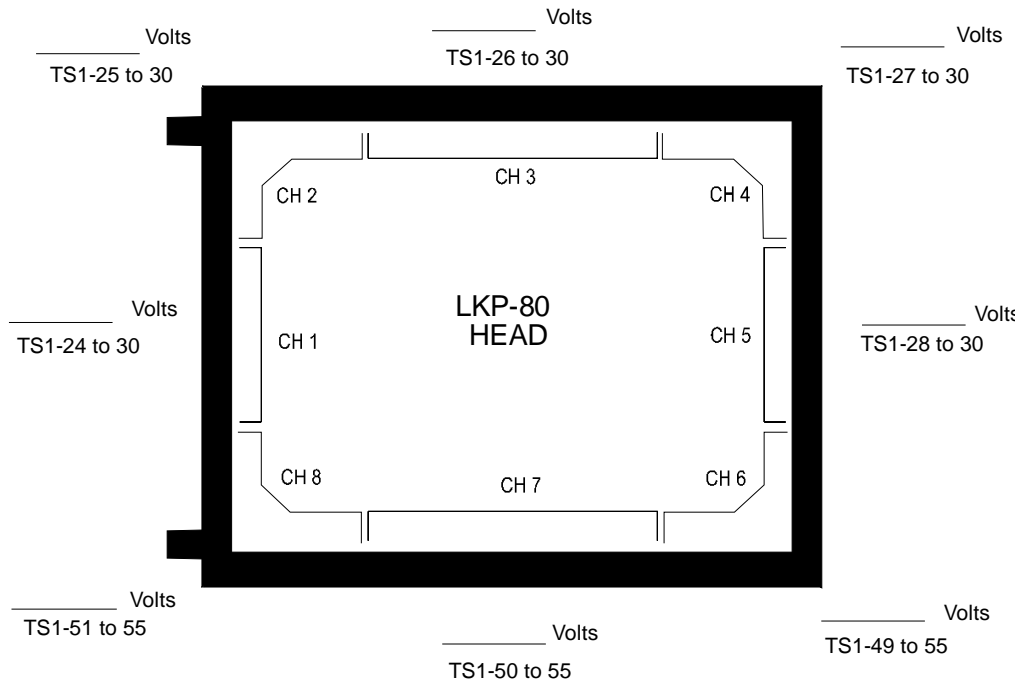

CHANNEL VOLTAGES

Ambient Temperature: _____

Date: _____

<input type="checkbox"/> LOOP BURDEN (TS2-4 & -5)			
<input type="checkbox"/> LINE VOLTAGE: (TS1-2 & -3)			
<input type="checkbox"/> BUS CURRENT (kA):			

Serial Number of LKP-80: _____

This Page is Intentionally Blank

5. THEORY OF OPERATION

5.1 GENERAL

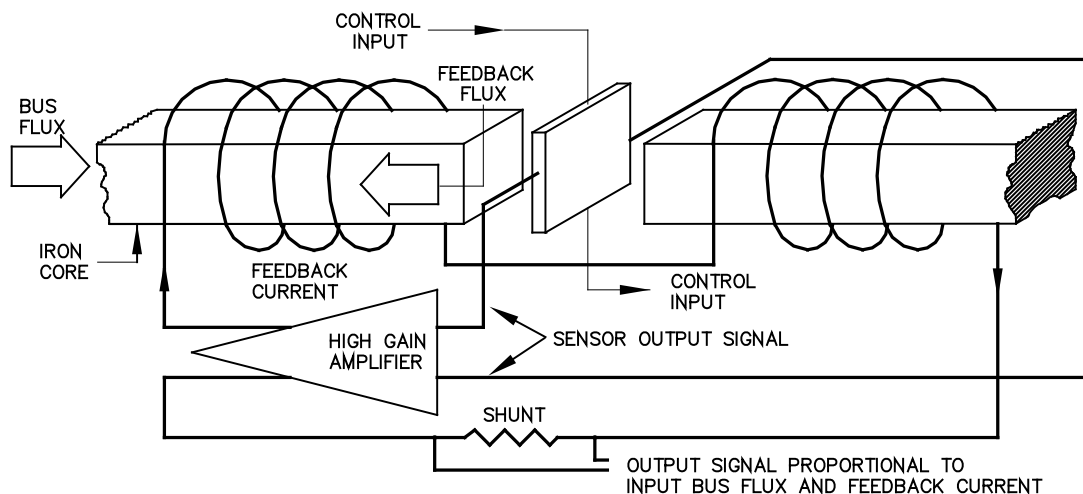

Figure 5.1 Magnetic Null Detector Diagram

A thorough knowledge of the LKP system theory of operation is essential for efficient troubleshooting. In figure 5.1 a portion of the Measuring Head is shown to illustrate the magnetic-null principle used in all Series LKP current measuring equipment.

5.2 MAGNETIC SENSOR (NULL DETECTOR)

The magnetic sensor produces a voltage output proportional to the difference between the bus field and the feedback field. The sensor output is amplified and is returned to the magnetic circuit in the form of feedback current. This current is passed through 5000 turns to produce the feedback field.

The Measuring Head contains many magnetic sensors and feedback coils. Each set of sensors and the adjacent coils plus the associated amplifying section of the Metering Unit is termed a channel. Each channel responds nearly independently of the other channels to null the bus field in its own section of magnetic core. However, after passing through their respective coil groups, all channel currents are summed to produce the output current. This current, which is always in the ratio of 1 A to 5000 A of bus current, is passed through resistors or shunts to develop voltages for the meter and proportional outputs. The output current itself is also available at the output terminals, which are jumpered if not used.

5.3 SYSTEM DESCRIPTIONS

Effects of stray fields are nullified by joining a number of magnetic assemblies like the one just described in a closed path around the bus. Figure 5.2 shows four such assemblies

(referred to as a 4-channel assembly). A 4-channel system is used here as an illustration to simplify the drawing and explanation.

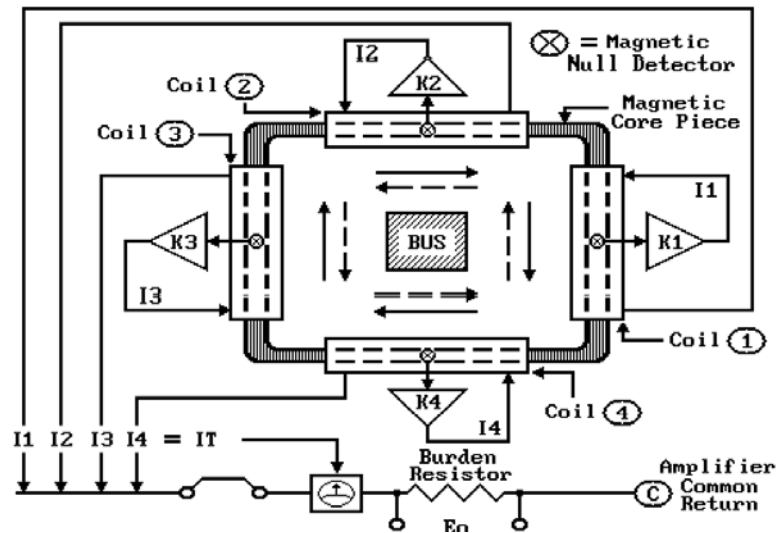

Figure 5.2 Functional Diagram of Four-Channel System

A magnetic null detector (sensor), high-gain current amplifier, and feedback coil are combined to form one channel, or current feedback loop. The function of each current loop (current I_1 , I_2 , I_3 , or I_4) is to maintain a state of zero flux in its related segment of the iron core. A burden shunt placed in series with the total current (I_t), develops an output voltage E_o , proportional to I_t . The common side of the shunt is returned to the four high-gain current amplifiers.

Since the bus current is directly proportional to the total current I_t by a ratio of 5000:1, the bus current can be measured accurately by summing the independent feedback currents ($I_t = I_1 + I_2 + I_3 + I_4$). Therefore, the bus current is equal to $5000I_t$. Moving the Measuring Head with respect to the bus will cause the values of the individual feedback currents to change but will not affect the total current nor the accuracy of the measurement.

5.4 CIRCUIT FUNCTIONS

For the following discussion refer to the “High Range Module Schematic” and system schematic drawings as appropriate. These drawings are located in the back of the manual.

Before discussing the various circuit functions, a general description of the Metering Unit will be helpful. A Metering Unit may consist of one or more modular units. Each modular unit contains the necessary circuitry for four channels of amplification. The Metering Unit also contains one main power transformer, circuit breaker, and the resistors or shunts to develop output voltages. A 4-channel system is used here as an illustration to simplify the explanation.

Each modular unit contains the necessary circuitry for four channels of amplification. The Metering Unit also contains one main power transformer, circuit breaker, and the resistors or shunts to develop output voltages.

Beginning at a magnetic sensor in the Measuring Head, we can trace the signal path. To achieve a signal output in the presence of a magnetic field, the sensor (Hall plate) must be supplied a small exciting current. This current is called the control current (I_c), and it is approximately 6 mA_{dc} for each sensor. The control current is derived from the 12 V_{dc} power supply in the Metering Unit. Since the sensor resistance is low (about 200 ohm), the sensor current is limited by two 1500 ohm resistors (one on each side of the sensor). These resistors are located in the Measuring Head.

With a constant dc control current applied to a sensor in the presence of a dc magnetic field, the sensor output is a dc voltage proportional to the dc field. The sensor output voltage is conducted via the interconnecting cable to the Metering Unit, where it becomes the signal input.

5.5 METERING UNIT

Although each modular unit contains only two circuit boards, it is comprised of several sub-circuits. Each of these circuits is described in the remaining paragraphs.

5.6 POWER SUPPLIES

The LKP module contains a ± 15 V_{dc} power supply, which powers only the on-board circuitry. The first module in the Metering Unit (also referred to as Module "A") contains a 12 V_{dc} power supply for the Hall devices.

5.7 SYNC, PLL, AND RAMPS

The Metering Unit employs phase locked loop circuitry for synchronization of the firing pulses of the SCRs. This particularly is an advantage when there is a high noise level present on the line voltage. The PLL circuitry consists of U101, U102, and associated circuitry. The line voltage is sensed at TP-4. It is then filtered and sent to U112 to be converted into a squarewave, and then to the PLL circuitry. The output of the PLL is a square wave and is present at TP-2. This signal is sent to U104, U105, and RP101, which constitutes the ramp generator. The ramp generator output consists of two downward sloping ramps, each 180 degrees out of phase from one another. Both ramps are sent to the quad comparators (U110 and U111) which are used to generate the firing pulses for the SCRs.

5.8 ERROR AMPLIFIERS

The error amplifier circuitry consists of U106 through U109 and associated circuitry. The error amplifiers serve two purposes, to amplify the Hall error signal and to filter it before sending it to the comparators.

5.9 COMPARATORS AND PULSE GENERATOR

The comparators consist of U110 and U111. They compare the amplified and filtered output of the error amplifiers to the two ramps generated by PLL and ramp generators. Two

squarewaves are generated at the output of these comparators, one for the positive half cycle and one for the negative half, (pins 1 and 2 of U110 for channel #1). One square wave will be used to trigger an SCR on the positive half of the waveform, and the other will be used for the other half cycle. Since these squarewaves are too long in duration, they cannot be used directly to drive the pulse transformer drivers. The comparator output is "ANDed" (the mathematical **product** of a logic AND gate) with several pulses generated by the PLL. The output, (pins 3 and 4 on U113 for channel #1) will be a pulse train, which will be used to drive the pulse transformer drivers. Pulse train triggering is an advantage when noise on the line turns off an SCR. The SCR is re-triggered allowing a minimum off time. Since these pulses are fixed and do not move, if they alone were used to drive the SCRs, the output would be very jumpy. This was smoothed by also anding the comparator with an integrated output of itself to give the output pulse train infinite resolution.

5.10 PULSE TRANSFORMER DRIVERS

The pulse transformer drivers consist of U203, U204, and associated circuitry. A pulse train signal is sent into the drivers (pin 2 and 1 of U203 for channel #1). These drivers are open collector outputs which drive the pulse transformers (T203A and T203B for channel 1). The secondary of the pulse transformer develops a current pulse which drives the associated SCRs (SCR pack #1 for channel #1).

5.11 OUTPUT CIRCUIT

Six outputs are provided by the system:

- 1.) A standard voltage output of 10 mV/kA, at TS2-6 and TS2-7, for LKP-45 and LKP-60.
- 2.) A standard voltage output of 1 mV/kA, at TS2-6 and TS2-7, for LKP-80.
- 3.) An optional voltage output of 1.0 Vdc at full scale rating, at TS2-8 and TS2-9.
- 4.) A current output of 1 Adc per 5 kA of bus current, at TS2-4 and TS2-5. The current output is available by removing a jumper connected across the TS2 terminals (do not remove the jumper while the system is energized). Maximum allowable voltage drop across the terminals is 15 Vdc at maximum bus current.
- 5.) A normally-open (N.O.) contact for the Metering Unit over temperature alarm, rated at 120 Vac, 6 A, at TS2-10 and TS2-11.
- 6.) Optional isolated shunt output. Scaling is per customer order: 0-10V, 4-20mA available.

Burden resistors inserted in the series output circuit should be selected with care. The wattage rating should be at least two times higher than the calculated power dissipation. The burden resistor should have a low temperature coefficient (25 ppm or better).

The LKP 6 and 8 channel Metering Unit is supplied with a two-pole circuit breaker mounted inside the enclosure, on the main panel.

5.12 ACCURACY DIAGNOSTICS (OPTIONAL)

"ACCURACY DIAGNOSTICS" (AD) is a system that assures the user that most internal circuits are operating properly and it is also a diagnostic tool. It is made up of a number of

circuits, monitoring conditions of many of the critical components, circuits and connections within the current monitoring system. The AD subsystem provides relay contacts for the user to connect to his remote warning indicator. The AD diagnostic light emitting diodes on each Metering Unit module indicate proper operation of associated circuits. On some larger systems a red warning light mounted on the enclosure door provides a simple visual warning (refer to wiring diagram for this feature).

The AD indicates the feedback circuits are functioning properly and the system's power supplies are within specifications. More specifically, this indicates the following conditions exist:

1. All channels have a core magnetic flux null:
 - a. All components in the circuits appear to be operating normally.
 - b. Input fields are of the expected polarity.
 - c. Input magnetic flux appears balanced by feedback flux.
2. Power supplies are operating within acceptable ranges.
 - a. Mains input power is on.
 - b. Hall plate sensor power supply output is correct.

With unidirectional LKP measurement systems, it is possible that the AD circuits will give a warning indication when the system is operated at low rectifier current level, even though all circuits and components are functioning properly. This warning at low levels is most likely to occur if the metering system is associated with only one of several rectifiers in the area.

The AD outputs indicate the present condition, having only a short time delay from an instantaneous condition. Although the AD does not monitor absolutely every possible error condition, it is an effective means of giving the user continual assurance of signal reliability.

- A.) If the "Diagnostics Relay" is O.K. and the green LED indicators are all on: Continue operating normally.
- B.) If the "Diagnostics Relay" indicates a warning and one or more green indicators are off:

This indicates there may be measurement errors. Consequently, the metering system should not be in full, automatic control of the rectifier. The AD relay contact output is not intended to be the only monitor protecting the power rectifiers. Primarily, it is expected that the customer wants to take immediate action to prevent unsafe operation. Unsafe operation could result if the metering system is in the rectifier control loop and it erroneously produces a significantly lower output than is true. This might cause the rectifier control circuit to inappropriately increase the power output, perhaps to overload levels for either the power supply or the process. So, if the metering system is in the control loop and the "Accuracy Diagnostics" indicates a potential problem, the following actions are recommended: FIRST- Lock out control actions that could drive the rectifier output higher and SECOND-alert the operator.

Basically, each module inside the Metering Unit has four channel LEDs and two power supply monitoring LEDs. The following is a description of their functionality:

- A. Line: This LED indicates whether the supply voltage to the Metering Unit falls within the specified limit of +10%, -15% of nominal. Significant changes from these values will cause this LED to turn off and trip the relay.

- B. Hall P.S.: This LED indicates whether the Hall plate supply voltage supply voltages fall with the specified operating limits. A failed Hall plate power supply or a line voltage out of specification will extinguish this LED and trip the relay.
- C. Channel LEDs: Each channel LED indicates the status of the corresponding channel to aid quick troubleshooting. An extinguished channel LED can be caused by the following:
 - a. A blown channel fuse;
 - b. A bad connection between the cable and the Metering Unit or cable and Measuring Head;
 - c. A bad Hall device in the head;
 - d. An open /or shorted coil in the head;
 - e. A primary current that exceeds the dynamic measuring range of the Metering Unit;
 - f. The primary current is too low to activate all channels properly;
 - g. A strong external magnetic field causing a channel reversal.

Notes on items f and g above:

- 1.) Under certain conditions, external magnetic fields can reverse one or more channels in the Measuring Head. The accuracy indicators will show an error in those channels until the bus current level rises high enough to effectively turn on all channels (2-3Vdc is the minimum reliable channel voltage). This condition can cause false alarms. For more information on this, please refer to technical bulletin TEC9908, "Resolving External Magnetic Field Errors".
- 2.) In some installations, when the channel voltages are balanced, the channel LEDs will remain on, even though the bus is turned down to zero. In this case, the accuracy diagnostics circuit is in an unstable condition and alarm faults, as indicated by the channel LEDs, should be ignored. Note that, in general, the Metering Unit's 0.1% accuracy is only guaranteed when the primary bus current is above 5% of the full scale rating of the unit.

A relay contact output is available to connect to a remote warning system. The relay is closed under normal operating conditions and opens when a fault condition occurs. The output connections are available via a connector located on the left side of the Metering Unit. The terminals are designated on the appropriate interconnection diagram. The terminals are used as follows:

Contact Terminals		Condition
TS2-12,13	TS2-13,14	
Open	Closed	Fault condition, zero bus current*, or Metering Unit turned off
Closed	Open	NORMAL OPERATION

* See notes above on zero bus current condition.

6. MAINTENANCE & SPARE PARTS

6.1 PERIODIC MAINTENANCE

As is true with any electronic circuitry, proper maintenance will prolong the service life. DynAmp, LLC recommends the following program be performed at the recommended interval to prevent or detect damage to the LKP system and to ensure continuing high-accuracy performance. Always use appropriate measures to correct any problems found. Following the suggested maintenance schedule may assist in early diagnosis of problem(s) to minimize repairs and down time.

IMPORTANT NOTE:
Keep organized, accurate recorded data (forms, etc.) from each Periodic Maintenance. This information may be invaluable in troubleshooting a malfunctioning LKP system.

6.2 ANNUAL MAINTENANCE

Perform the following steps at least once per year. If LKP system equipment is exposed to outdoor temperatures, DynAmp, LLC recommends these steps be performed during the hottest time of the year.

The following procedures should be performed at the recommended interval to prevent or detect damage to the LKP system and to ensure continuing high-accuracy performance. Use appropriate measures to correct any problems found.

- A.) Repeat voltage measurements given in "Magnetic Centering" procedure to ensure that no significant change has occurred from the data recorded at startup. A large change in the amplifier output voltage of a given channel (compared to other channels) may indicate trouble in the channel. If all channels change proportionally, then that might indicate a change in the bus current. A lesser, but significant, change in a voltage measurement should be corrected by re-centering the head. Remember that channel voltages will vary slightly depending on the ambient temperature of the Measuring Head.
- B.) Measure and record the Hall device dc power supply voltage.
- C.) Visually inspect Measuring Head and interconnection cable for evidence of severe overheating or excessive corrosion. Record any suspect conditions.
- D.) Inspect and touch-up the seals between the window insulation and the aluminum frame of the head. Reseal as necessary.
- E.) Inspect & replace if required the gasket between the cable connector and the mating head connector.
- F.) Inspect the condition of the pins and sockets and clean out any corrosion.
- G.) Visually inspect Metering Unit and signal converter(s) for evidence of severe overheating, or excessive corrosion. Record any suspect conditions and take appropriate action.

- H.) Inspect all bolts on the Measuring Head and torque any that might have come loose. Observe proper torquing techniques and specs carefully.
- I.) Clean the following items:
- 1.) Cables and external surfaces of Measuring Head and Metering Unit:
Clean as necessary; remove any oil or grease with a mild detergent or cleaner solvent. Do not use strong chemical solvents as they may damage the cables or erase the silk-screening from the Metering Unit.
 - 2.) Metering Unit interior (should only be performed after disconnecting power to the Metering Unit): Dust and dirt can be removed by gently vacuum cleaning the unit. Be careful not damage the internal shunt. Solvents should never be used on any of the PC boards. The boards are coated with a protective conformal coating, which can be stripped away by certain solvents.
- J.) Check the electrolytic filter capacitors for seals that have been popped (degassed) or are leaking electrolytic fluid. Replace if necessary.
- K.) If the unit is equipped with a cooling fan and filter, then the filter should be cleaned or replaced according to the manufacturer instructions.

CAUTION
To avoid the risk of shock and electrocution, always disconnect the AC power and head cables from the Measuring Head before performing any cleaning or service operation on the Metering Unit.

Disconnect power to the system before servicing or replacing fuses.

6.3 RECOMMENDED CALIBRATION VERIFICATION INTERVALS

DynAmp does not specify required intervals of calibration for its products.

The end user of the product is responsible for identifying the appropriate interval between calibrations. The intervals should be determined based on the following factors:

- Requirements of a Quality Management System
- Accuracy and permissible limits of errors
- Purpose and usage
- Experience with similar products
- Manufacturer's recommendations
- Stability of the product
- Past history
- Other characteristics of the product

Reference: "ISO/IEC 17025:2017, General requirements for the competence of testing and calibration laboratories" and Laboratory Accreditation Bureau "Guidance for Documenting and Implementing ISO/IEC 17025:2017 and Laboratory Guidance."

As a guideline, DynAmp recommends a 24-month interval of calibration for all permanently installed products and a 12-month interval of calibration for all products used in portable applications.

6.4 SPARE PARTS ORDERS - ROUTINE OR EMERGENCY

Requests for spare parts should be directed to "Service" at DynAmp, LLC during normal hours. When contacting us, please present as much information as possible, such as the related equipment Model and Serial Numbers (available on the equipment tag); the required part name; its DynAmp, LLC item number (and other identifying or vendor number(s)); and your time needs. An approved Purchase Order Number should be given with your order.

6.5 RECOMMENDED SPARE PARTS

The following table lists the minimum recommended quantities* for spare parts for the LKP Series 6 & 8 Channel. As spares are used, replacements should be ordered. Since continuous operation of high-current measurement systems is usually critical, stocking spare parts should be given high priority.

A single module "A" kept on hand (see part number below) can be used to replace either of the modules in the Metering Unit and guarantee quick, error free repair. Note that a module "B" cannot be used to replace a module "A" but the reverse is true.

The LKP Series Measuring Heads require special repair procedures and materials. However, the heads are very reliable and should require little or no repair over its service life. Please refer to the nearest authorized DynAmp service center for information on repairs.

**TABLE 6.1
SPARE PARTS LIST***

DESCRIPTION	ITEM NO.	QUAN
Metering Unit		
Kit, Spare Parts, LKP-45	43787	1
Kit, Spare Parts, LKP-60	43788	1
Kit, Spare Parts, LKP-80	43789	1
Spare Parts Kit includes Module, Fuses and Bulb as one package.		
LKP Hi Range Module "A"	41413	1
Bulb, POWER ON light	42121	1
**Fuses, LKP-45 (channel fuse, 2.25 Amp) (5 per box)	46951	2 box
**Fuses, LKP-60 (channel fuse, 4 Amp) (5 per box)	12592	2 box
**Fuses, LKP-80 (channel fuse, 4 Amp) (5 per box)	12592	2 box
**Fuse, Module ac Supply (located on TS1-9, 6.25 AMP.) (All)	12594	2
Options		
***Accuracy diagnostics PCB, (4) Channel main board (1 used in LKP-45, 60 or 80)	41314	1
***Accuracy diagnostics PCB, (2) Channel main board (1 used in LKP-45 or 60)	40402	1
***Accuracy diagnostics PCB, (4) Channel main board (1 used in LKP-80)	40355	1

- * For one to five units, stock the quantities shown. For six or more units, a complete system (head, cable, and Metering Unit) should be kept on hand.
- ** All Fuses are Time lag MDA (or MDL) style 3AB (or 3AG) ¼" by 1 ¼" (6.3 mm x 32mm), 250 Volt
- *** Only required if accuracy diagnostics option is installed.

Disconnect power to the system before servicing or replacing fuses.

7. RELATED TECHNICAL BULLETINS

The following is a list of available technical bulletins that contain relevant information in regards to high current measurements and the use of LKP systems. The technical bulletins are available upon request from DynAmp, LLC. Always consult the factory for a list of the latest technical bulletins.

**TABLE 7.1
TECHNICAL BULLETIN LIST**

NUMBER	SUBJECT	TITLE / DESCRIPTION
9908	External Fields	Resolving External Magnetic Field Errors (replaces TEC727)
9907	LKP/ LKB	LKP and LKB Sensor Mounting Guidelines and Restrictions
9905	LKP/ LKB	Recommended Calibration Intervals for LKP or LKB High Current Systems
9904	Diagnostics	Self Diagnostics for DynAmp High Current Measurement systems (Accuracy Diagnostics)
987	LKP/ LKB	Ferromagnetic Materials near LKP or LKB High Current Measurement Systems
749	Bus Analysis	Computer Analysis of Measuring Head Locations In High Current Measurement systems
748	LKP/ LKB	Guidelines for locations of LKP or LKB High Current Systems Measuring Heads on Busses
747	kWH	Volt-hours times Ampere-Hours is NOT equal to Watt-hours
941	Bus Analysis	Data required for Bus Analysis of High Current Measurement Systems

This Page is Intentionally Blank

8. DRAWINGS

**TABLE 8.1
DRAWING LIST**

DRAWING TITLE	NUMBER	REVISION
Outline and Mounting: LKP-45 Measuring Head	02A108100	A
Outline and Mounting: LKP-60 Measuring Head	02A108101	A
Outline and Mounting: LKP-80 Measuring Head	02A108102	A
Assembly: Mounting Feet LKP Series	02A108256	B
Assembly: Bus Bar Mounting – LKP-15, -30 and -45	02A109641	-
Wiring Diagram: Harness Assembly, LKP Series I	83A108030	B
Assembly: Control Circuit PC Board, LKP System	75A108104	B
Assembly: PC Board Configuration LKP Universal Accuracy Diagnostics Board	07A109083	-
Schematic: LKP/CM Accuracy Diagnostics (Alarm) PC Board	05B109034	-
Wiring - Isolator & DPM Options 6 & 8 Channel LKP Metering Units	83A108255	C
Totalizing Diagram for CM & LKP Series Metering Units	02A108033	C
Outline and Mounting: LKP 6 & 8 Channel Metering Unit	02B107876	B
Assembly: Supply & SCR Drive PC Board LKP Modules	75B108106	B
Schematic: LKP 4 Channel High Range Module	05B108074	B
Interconnection Diagram: LKP-45	02B107939	E
Interconnection Diagram: LKP-60	02B108197	C
Interconnection Diagram: LKP-80	02B107941	C
Schematic: LKP-45 & 60 Metering Unit	05B107949	C
Schematic: LKP-80 Metering Unit	05B107951	C
Wiring Diagram: LKP-45 Measuring Head (TM 10-45)	83B107967	C
Wiring Diagram: LKP-60 Measuring Head (TM 20-60)	83B107968	D
Wiring Diagram: LKP-80 Measuring Head (TM 20-80)	83B107969	C
Wiring Diagram: LKP-45/ 60 Metering Unit	83B107944	E
Wiring Diagram: LKP-80 Metering Unit	83B107946	D