

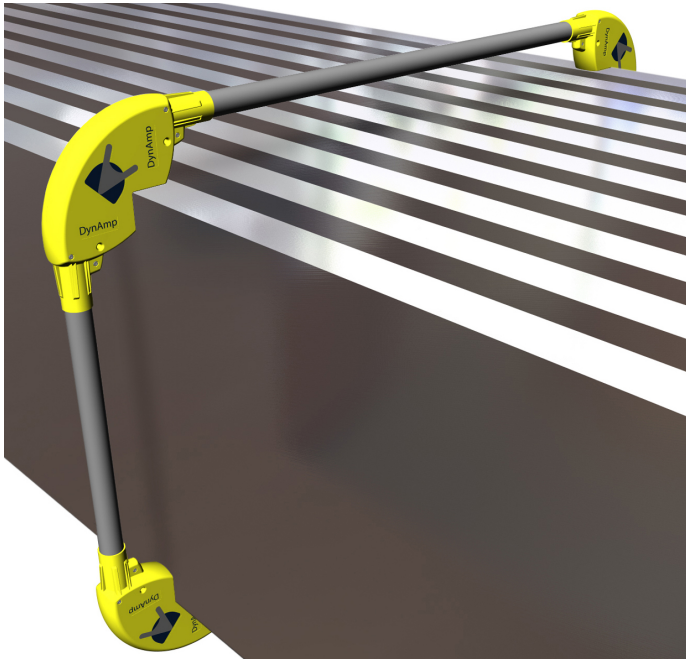

DynAmp

# LKCO

## Fully Compensated, Closed-loop Fiber Optic High Current Measurement



### Description

LKCO represents a significant breakthrough in high current measurement. Advanced optical technology senses the phase shift in light caused by the magnetic field from the bus current when it is routed around a current carrying bus via fiber optics.

LKCO utilizes a unique, patented "fully compensated" closed-loop system, developed over 8 years of lab and field experience, to ensure long-term performance. LKCO achieves this by putting the entire system ( light source, opto-electronics, fiber optics and measurement output signals ) under complete closed loop control which automatically compensates for any sensitivity, gain, drift or zero point change.

### Application

LKCO is particularly well suited to measure process bus currents in electro-chemical and industrial processes including aluminum, chlorine, copper, manganese, titanium and zinc for process efficiency and control purposes

### Key Features

- **Superior, rejection of external influences.** Permits installation on compact and geometrically complex bus work. No need for DynAmp Bus Analysis or exact positioning to optimize performance.
- **Excellent Low Current Performance** thanks to true bi-directional operation and near perfect integration of the bus magnetic field.
- **Extremely compact and light-weight.** Designed to be "bus bar mounted". Eliminates additional support and protection structures. Compact modular head allows installation with less than 20cm of bus clearance
- **Patented Closed-Loop "Full Compensation"** places the entire system (light source, opto-electronics, fiber optics and even measurement outputs) under closed loop control to automatically compensate for long term changes.

- **Advanced Accuracy Diagnostics (A<sup>2</sup>D)** continuously monitors system operation and performance to enhance measurement confidence. A<sup>2</sup>D notifies user of specific installation problems, developing problems and faults. A<sup>2</sup>D even records events for subsequent analysis and root cause investigation and is available via digital connection.

### Technical Overview

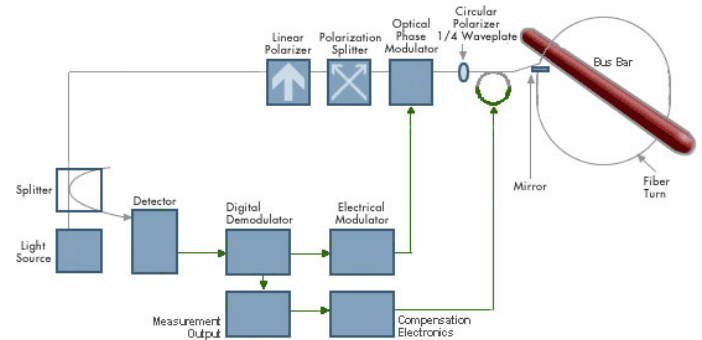

- 1) Polarized light is split into two linearly polarized light waves.
- 2) The two linearly polarized light waves are converted to circular polarization before traveling around the bus, reflecting off the end of the fiber and returning along the same path. The bus magnetic field creates an optical phase shift due to the Faraday effect. Because the two light waves are polarized in opposite directions, the shifts are in opposite directions. Other conditions, such as vibration, also create an optical shift but affect the two light signals in the same direction, therefore not changing the "measurement" shift.
- 3) The two light waves return to the opto-electronics where phase shifts are measured for a 'raw' measurement signal

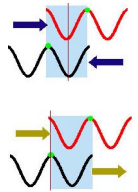

- 4) **Patented closed-loop full compensation** accurately nulls this shift electromagnetically in the same medium that sensed the bus current. This automatically compensates for any gain, sensitivity and zero point change or long term drift in the entire system ( light source, opto-electronics, fiber optics and measurement output signal ).

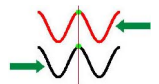



**Physical Configuration**

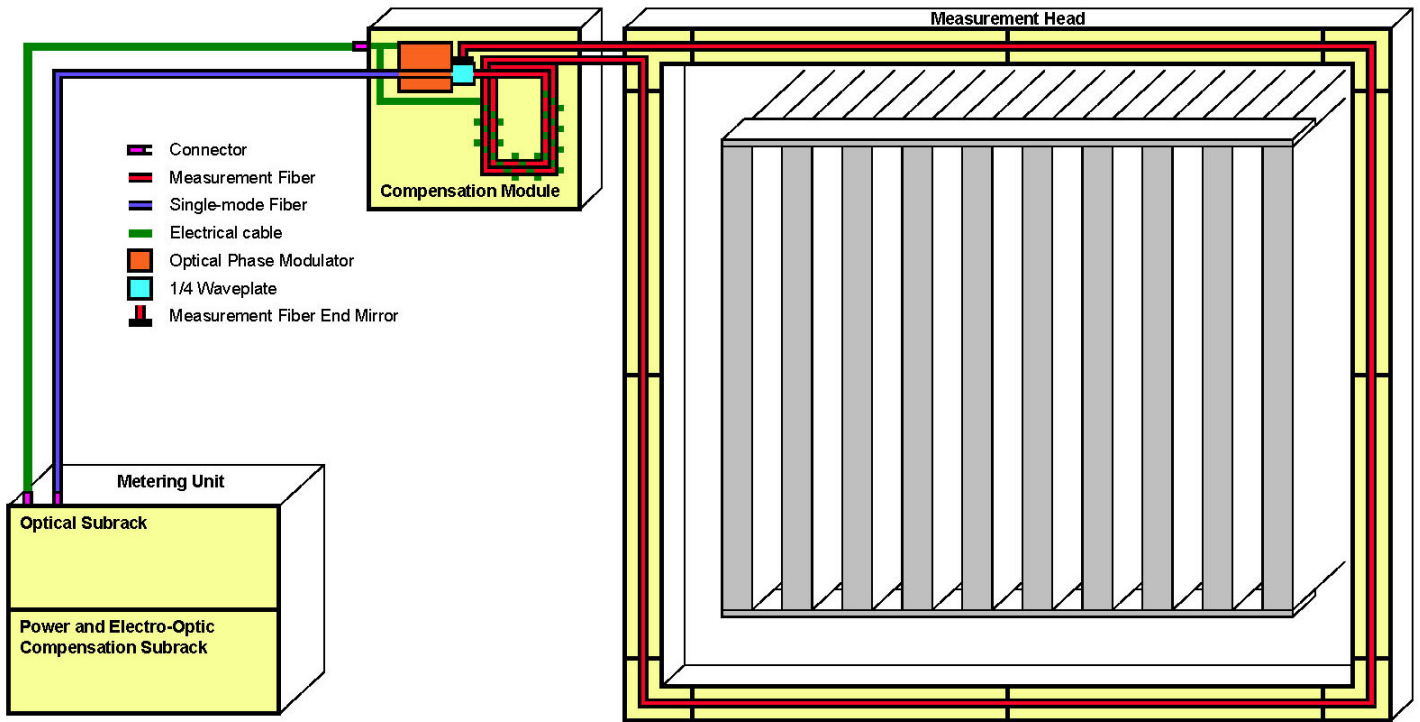

**Specifications** (Subject to change without notice)

**Input :** Bus Current to +/- 600 kA full scale  
Over-current 110% of F.S. measurement  
Infinity without damage

**Measurement Performance** (applies from 10% to 110% of F.S.):  
Measurement accuracy ±0.1% of measurement  
Repeatability ±0.02% of measurement  
Linearity ±0.1% of full scale

**Measurement Outputs :** Uni-directional or bi-directional  
Standard : Low Level Shunt Voltage Feedback Current (5V max burden)  
≤ 100kA 10mV / kA or 1V FS 1A FS  
> 100kA 1mV / kA or 1V FS 4mA/kA (250000:1)

Optional : Low-level current 0/4...20mA full scale  
High-level voltage 0 to +/- 10V FS  
Frequency 0 to 10kHz full scale  
Digital / network ModBus or ProfiBus  
Digital display Internal or remote

**Mains** 95...264VAC@47...63Hz or 100...264VDC  
350VA w/o environmental options

**Isolation** (Hi-Pot tested at 60Hz)  
Head to output / chassis 6.0kVAC for 1 minute  
Mains supply to output 1.5kVAC for 1 minute  
Mains or Output to chassis 1.5kVAC for 1 minute

		Operating	Storage
Measuring Head	IP65	-40° to 70°C	-40° to 70°C
Compensation Module	IP65	-40° to 70°C	-40° to 70°C
Metering Unit	IP54	-10° to 40°C*	-40° to 70°C

\*Metering Unit requires fan option from 30° to 40°C  
or air conditioning option for over 40°C ambient,  
requires heater option below -10°C

Humidity (non-condensing) 0 to 85C% 0 to 85%

**Metering Unit to Compensation Module Cabling**

DynAmp supplied cabling : 30m standard  
Connectors at Metering Unit

**Physical**

Metering Unit 61cm w x 77 h x 54 d  
Compensation Module 44cm w x 39 h x 17 d  
Measurement Head Modular, sized to bus  
(10cm x 10cm cross-sec)

**Measurement Head Mounting Configurations**

Wall / Other Structure

Bus Corner

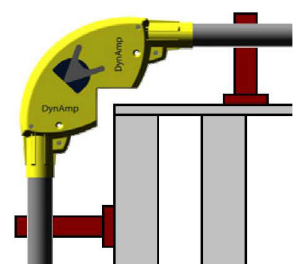
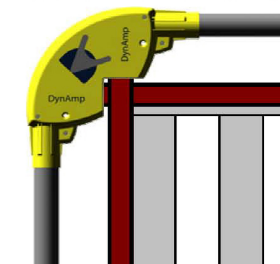
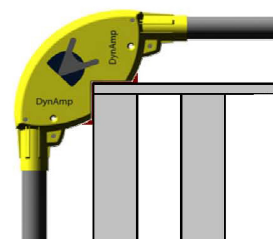
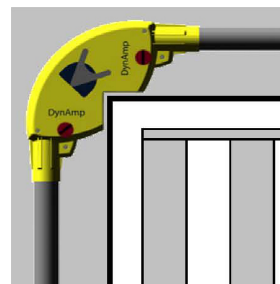

Bus Suspended – OPTIONAL

Bus Bracket – OPTIONAL



## Frequently Asked Questions

### ***How difficult is the LKCO to install and commission?***

Due to the delicate nature of the LKCO components before they are assembled into their finished form on-site, DynAmp highly recommends utilizing one of our technicians in the installation and commissioning process.

The LKCO is quite lightweight eliminating the need for hoists, cranes, etc. Two people can easily move all of the LKCO components, assemble and position the head structure, place the measurement fiber in the head structure, connect everything together and switch on. The measurement head structure size can be easily adjusted on site with hand tools to provide a perfect fit.

Once switched on, the LKCO Advanced Accuracy Diagnostics checks the electrical, fiber and optical connections and subsystems identifying and specifically reporting any problems found. In addition, with the proper data connection, DynAmp can access the LKCO remotely to check the system operation.

If a DynAmp commissioning technician is utilized, he will also check the performance of the LKCO after installation using DynAmp's portable Opti-Cal system.

### ***How close / far from the bus must the head be installed?***

The LKCO is very flexible in this regard. Generally, as long as the measurement head and sensing fiber encircle the bus, its exact positioning does not matter. For example, if the installation requires that the head be tilted or angled around the bus, this has no effect on system performance.

### ***Can fiber length between the compensation module and metering unit be changed in the field?***

Yes, the method is the same as cutting and re-splicing standard telecom fiber. This requires some specialized equipment and training. In most cases, we suggest this be done by DynAmp personnel or by utilizing a certified subcontractor that is already doing this in fiber-optic telecommunications applications.

### ***If the fiber assembly is damaged, how can this be fixed?***

Standard single-mode fiber is used to connect the opto-electronics to the compensation module. This is standard telecom type fiber. If damaged, it can be repaired in the field by splicing in replacement fiber or cutting out a damaged section and splicing it back together as noted above.

The measurement fiber in the head is highly specialized. If damaged, it must be returned together with the compensation module to DynAmp for repair. The entire assembly can be easily placed in a standard shipping box. There is no need to return the head structure or the metering unit.

### ***What diagnostics are included?***

The LKCO Advanced Accuracy Diagnostics (A<sup>2</sup>D) monitors a wide variety of system parameters to provide users with measurement confidence and notify them of any developing problems or failures. A<sup>2</sup>D monitors both the opto-electronics as well as the fiber optic circuit in this regard and provides local LED indication, relay output for remote indication and event recording capability to capture any intermittent problems for subsequent analysis. Once notified, users can view and analyze detailed information on a PC via a user-friendly graphic interface. This can be performed locally by user personnel or remotely over network connections. If a connection is provided by the user, DynAmp can also access this function remotely to assist without having to travel to the site.

### ***How and how often should the LKCO be calibrated?***

The patented closed-loop compensation of the LKCO, similar to our LKP systems, effectively locks calibration. There are no normal calibration 'adjustments'. The only way that calibration can change is if a technical problem develops. The system's Advanced Accuracy Diagnostics continuously monitors the system and notifies operators if a problem is detected. Understanding the importance of the data, DynAmp still recommends that calibration be checked every 3 years on systems installed on the main process bus bar.

Thanks to the compact, light-weight aspects of LKCO, this is quite easy. The customer can simply remove and ship the compensation module with the measurement fiber to DynAmp for calibration on our highly accurate test stand. DynAmp can organize a rental system if a suitable backup signal is not available to run the process during that time.

### ***Is there a simple on-site calibration check?***

As with our LKP systems, the LKCO can be checked in the field using a specialized reference system. In the past, DynAmp checked installed LKP systems with another specially calibrated reference LKP system mounted on the same bus. While effective, this was logistically difficult due to the size and weight of the reference LKP system.

Understanding this, DynAmp has developed a special version of our LKCO technology to be used as portable calibration system. This lightweight, compact and portable 'Opti-Cal' system allows DynAmp personnel to quickly and easily perform calibration checks on installed LKCOs as well as our other systems including LKP.



## Standard System Includes

- Modular head structure for bus-bracket, bus-corner and wall head mounting
- Complete fiber assembly with compensation module including 30 to 50 meters of Interconnection cabling
- Metering Unit for wall mounting
- Operator / installation manual
- Calibration result data tables and graphs
- 2 year warranty
- Weather resistant shipping packaging

## Options

- **0/4...20mA Measurement Output Signal**  
Specify Item Number 044445
- **0...10V Measurement Output Signal**  
Specify Item Number 044880
- **0...10kHz Measurement Output Signal**  
Specify Item Number 044800
- **Additional 1V Full Scale voltage output signal** (only available if 'standard' voltage output is 1 or 10mV / kA)  
Specify Item Number on worksheet BEN083
- **Digital Bus Communications**  
Modbus (RTU) : Specify Item Number 044448  
Modbus (TCP) : Specify Item Number 045152  
Profibus : Specify Item Number 044449
- **3.5 digit LED Current Display**  
In Metering Unit (AC) : Specify Item Number 044446  
In Metering Unit (DC) : Specify Item Number 045179  
Remote mounting (AC) : Specify Item Number 043618  
Remote mounting (DC) : Specify Item Number 045180
- **Extended Interconnection Cable**  
Additional cabling between Compensation Module and Metering Unit for requirements over 30m.  
Specify Item Number 044989 additional in meters
- **Metering Unit Cooling Fan ONLY for AC mains**  
Thermostat controlled cooling fan to extend high temperature operating capability from 30°C to 40°C  
Specify Item Number 044451 for 115VAC mains  
Specify Item Number 044452 for 230VAC mains
- **Metering Unit Heating ONLY for AC mains**  
Thermostat controlled heating to extend low temperature operating capability from -10°C to -40°C.  
Specify Item Number 044453 for 115VAC mains  
Specify Item Number 044454 for 230VAC mains
- **Metering Unit Cooling Fan AND Heating for AC**  
Specify Item Number 044873 for 115VAC mains  
Specify Item Number 044874 for 230VAC mains
- **Metering Unit Air Conditioning**  
Active air-conditioning to extend high temperature operating capability above 40°C.  
Specify Item Number 044875 for 115VAC mains  
Specify Item Number 044876 for 230VAC mains  
( Can not be powered by DC mains )
- **DC Mains Option**  
Enables LKCO system to operate from VDC Mains  
( Environmental options require AC Mains )  
Specify Item Number 044877

## Accessories

- **Measurement Head Bus Bar Bracket Kit**  
Utilizes aluminum brackets, mounted to the bus bar, to hold the Measurement Head around the bus bar  
Specify Item Number 044514
- **Measurement Head Bus Bar Suspension Kit**  
Utilizes reinforced fiberglass cross members to suspend Measurement Head around the bus bar  
Specify Item Number 044878
- **Floor Stand for Metering Unit cabinet**  
Provides ability to mount Metering Unit enclosure as a free-standing unit.  
Specify Item Number 044455
- **Compensation Module Pedestal**  
Specify Item Number 045077
- **Spare Compensation Module w/ Fiber Circuit**  
Specify Item Number 045043
- **Spare Optical sub-rack for Metering Unit**  
Specify Item Number 045045
- **Spare Power sub-rack for Metering Unit**  
Specify Item Number 044591
- **Extended Burn-In :**  
Extended burn-in periods can be ordered in 24 hour increments. ( 4 hours standard )  
Contact DynAmp
- **Extended Warranty for LKCO systems  $\leq$  100kA:**  
Adds 24 month periods to the standard 24 months.  
For LKCO  $\leq$  100kA specify Item Number 099993  
For LKCO  $\geq$  100kA specify Item Number 099994

## Suggested Support Services

**On-Site Commissioning:** Factory trained technicians and specialized equipment on-site to verify correct installation and operation during start-up.

**Calibration:** Experienced service technicians with specially adapted calibration equipment are available to verify proper operation and validate your system measurement performance to internationally traceable standards on-site or at DynAmp.

## Required Ordering Information

All orders require completion of LKCO Worksheet BEN083 to be completed regarding the following factors

- Bus bar and area details for head size and installation determination
- Head/Compensation and Metering Unit locations for Head design and cable length determination
- Environmental details regarding head/compensation location and metering unit location for any required heating or cooling.

**NOTE :** Delivery lead-time can not be confirmed until acceptable BEN083 is received by DynAmp and customer approves subsequent head design.